

Data Sheet



Article number: 03445160

Description: Fluro Heavy Duty Spherical Plain Bearing GE 160 EW-2RS
Hole \varnothing 160

Note: 160

Measures

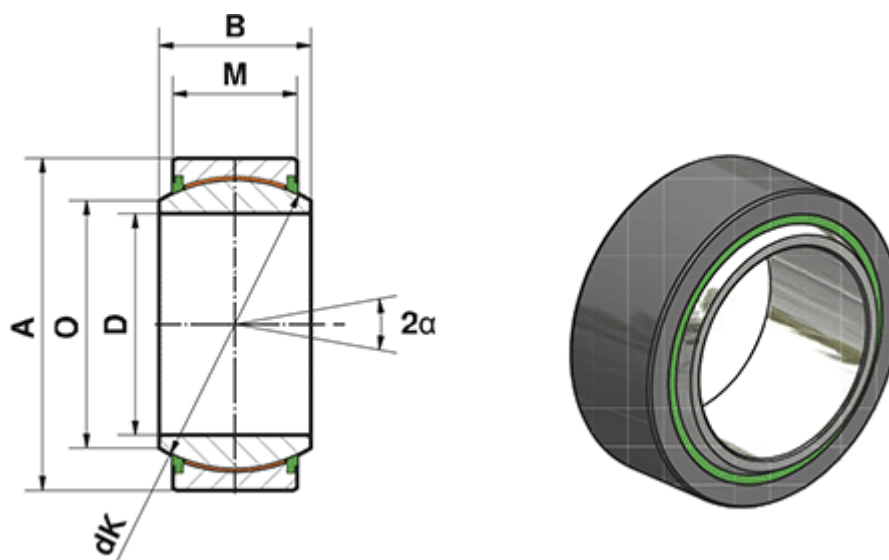

A	= 230	Static load C0 (kN) = 6400
a (degrees)	= 8	Weight (g) = 13800
B	= 105	
D	= 160	
dk	= 200	
Dynamic load C (kN)	= 3840	
M	= 80	
O	= 170.3	